



**ARCHITECTURAL
ALUMINUM
PRODUCT CATALOGUE**

TABLE OF CONTENTS



1-1	TABLE OF CONTENTS
2-1	DR SERIES DOORS - SYSTEM PARTS
2-2	DR SERIES DOORS - NARROW STILE TYPICAL DETAILS
2-3	DR SERIES DOORS - MEDIUM STILE TYPICAL DETAILS
2-4	DR SERIES DOORS - WIDE STILE TYPICAL DETAILS
3-1	SF175 SERIES STOREFRONT - SYSTEM PARTS
3-2	SF175 SERIES STOREFRONT - TYPICAL DETAILS
4-1	SF200 SERIES STOREFRONT - SYSTEM PARTS
4-2	SF200 SERIES STOREFRONT - TYPICAL DETAILS
5-1	CW200 SERIES CURTAIN WALL - SYSTEM PARTS
5-2	CW200 SERIES CURTAIN WALL - SYSTEM PARTS
5-3	CW200 SERIES CURTAIN WALL - TYPICAL DETAILS
6-1	CW250 SERIES CURTAIN WALL - SYSTEM PARTS
6-2	CW250 SERIES CURTAIN WALL - SYSTEM PARTS
6-3	CW250 SERIES CURTAIN WALL - TYPICAL DETAILS
7-1	MISCELLANEOUS - SYSTEM PARTS
7-2	MISCELLANEOUS - SYSTEM PARTS

DR SERIES DOORS

SYSTEM PARTS

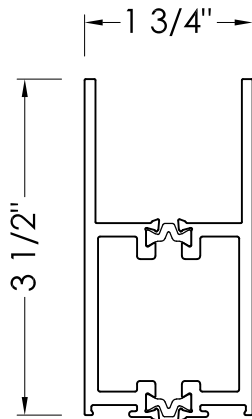

DR100
TOP RAIL

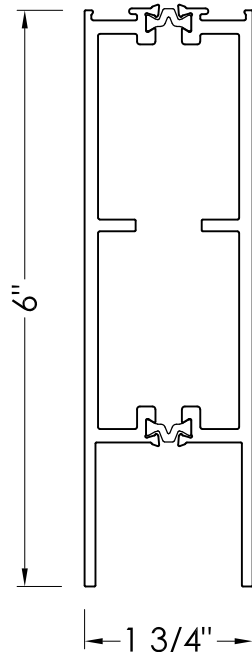

DR200
BOTTOM RAIL

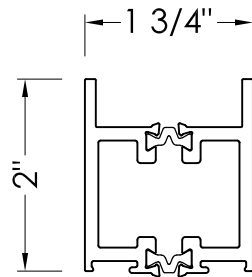

DR101
NS TOP RAIL

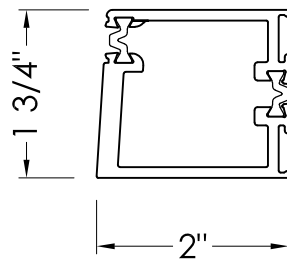

DS200
NS SINGLE ACTING STILE

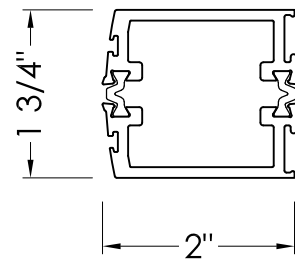

DS201
NS DOUBLE ACTING STILE

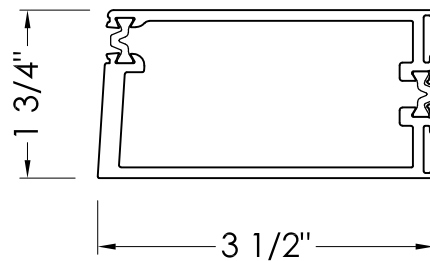

DS350
MS SINGLE ACTING STILE

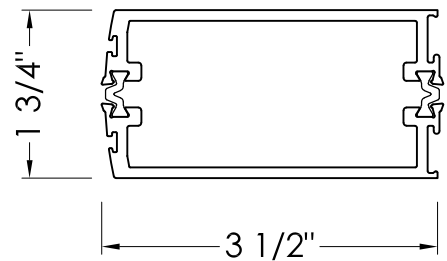

DS351
MS DOUBLE ACTING STILE

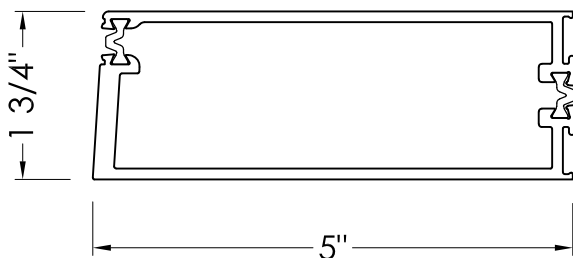

DS500
WS SINGLE ACTING STILE

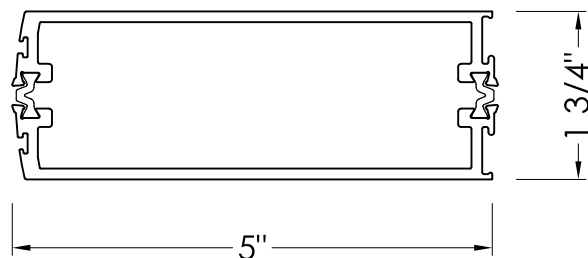

DS501
WS DOUBLE ACTING STILE

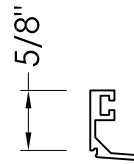

GSDG
GLAZING STOP
(DOUBLE GLAZED)

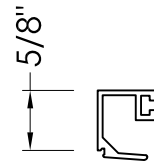

GSSG
GLAZING STOP
(SINGLE GLAZED)

DR SERIES DOORS

NARROW STILE TYPICAL DETAILS

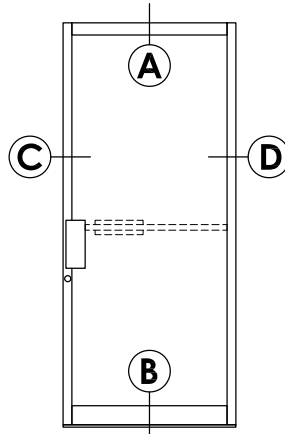
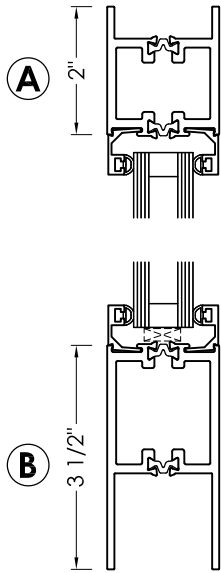

ELEVATION

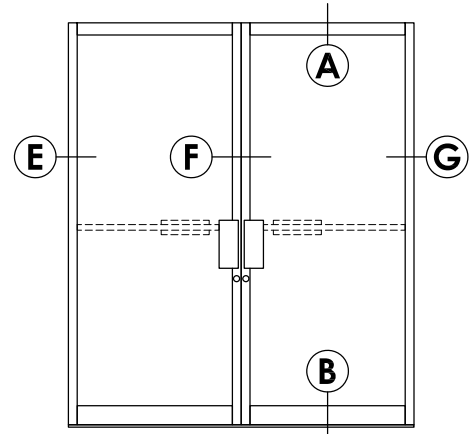

ELEVATION

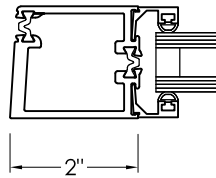

C

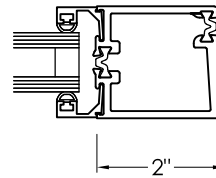

D

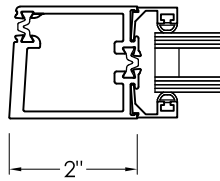

E

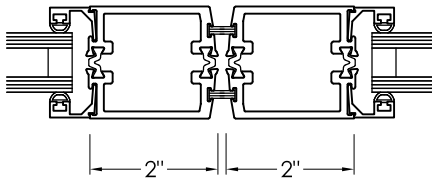

F

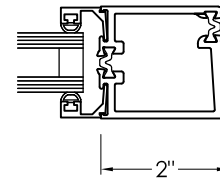

G

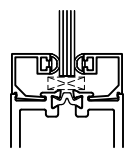

OPTIONAL
SINGLE GLAZED
STOPS

DR SERIES DOORS

MEDIUM STILE TYPICAL DETAILS

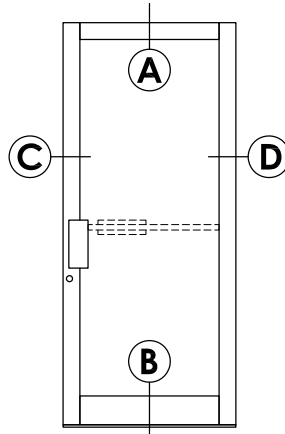
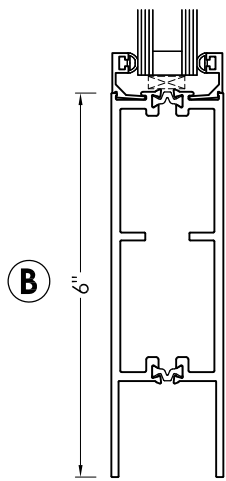
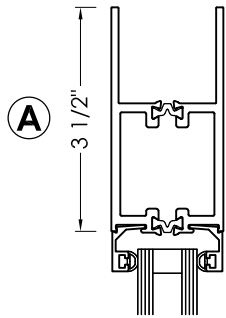

ELEVATION

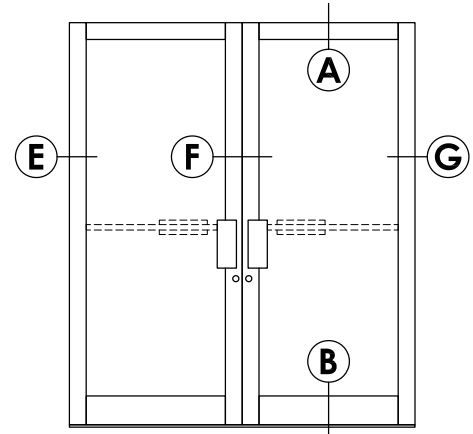

ELEVATION

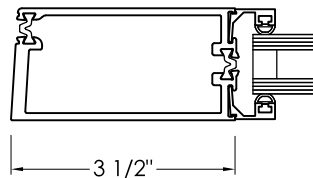

C

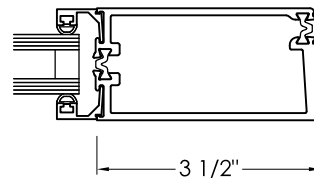

D

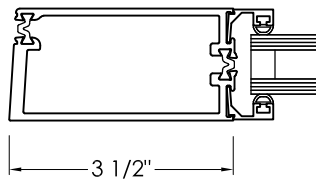

E

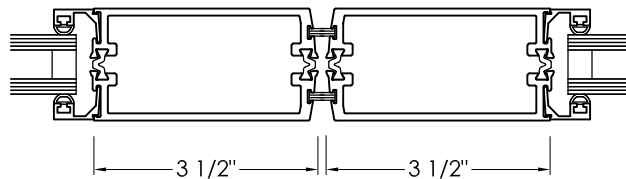

F

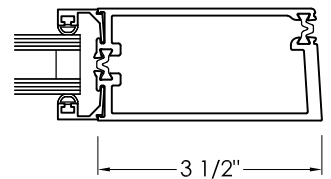

G

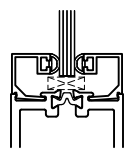

OPTIONAL
SINGLE GLAZED
STOPS

DR SERIES DOORS

WIDE STILE TYPICAL DETAILS

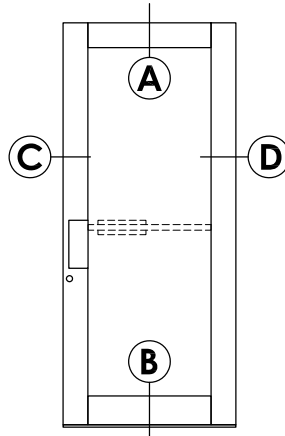
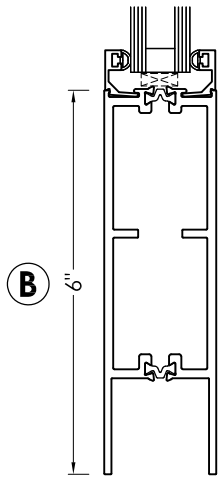
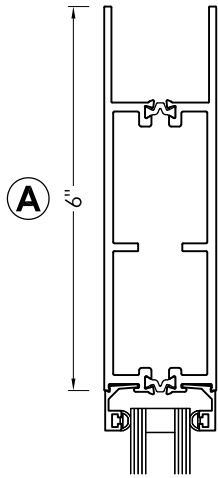

ELEVATION

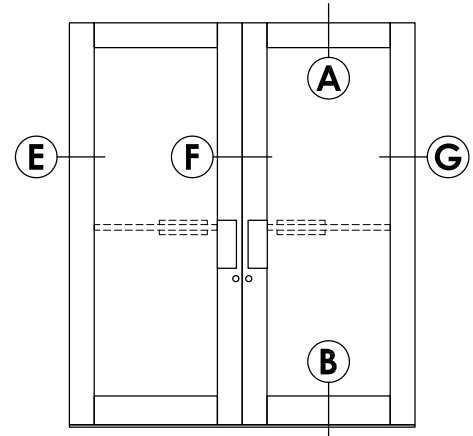

ELEVATION

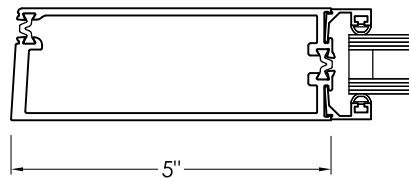

C

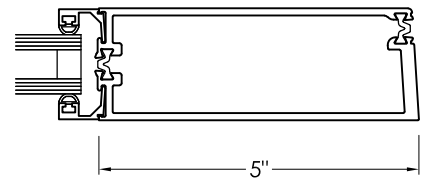

D

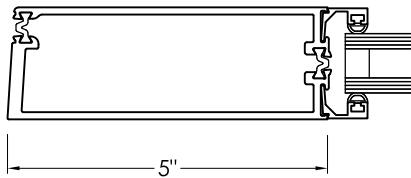

E

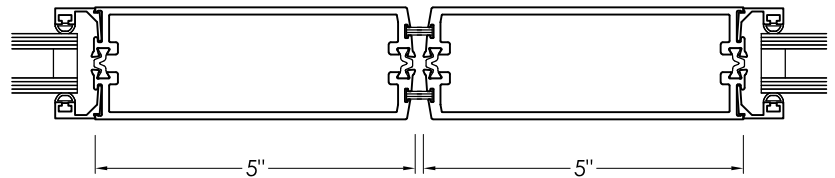

F

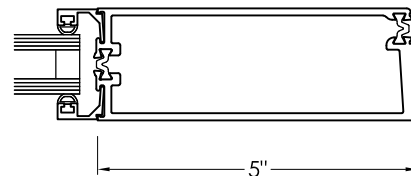

G

SF175 SERIES STOREFRONT

SYSTEM PARTS

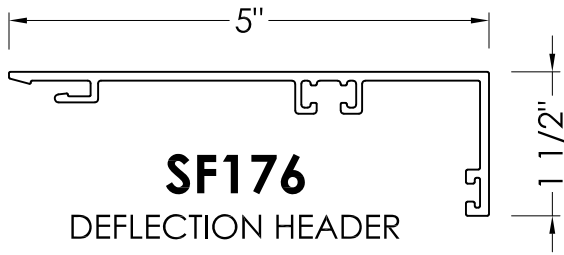

SF176
DEFLECTION HEADER

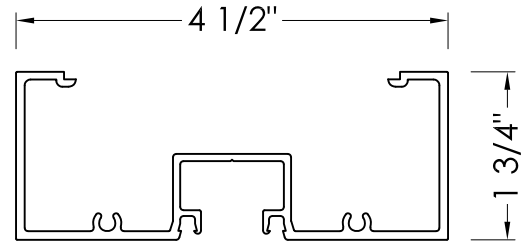

SF170
HEAD / JAMB / VERTICAL

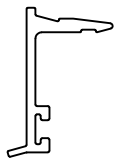

SF177
DEFL. HEADER STOP

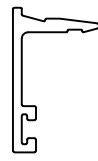

SF178
DEFL. HEADER STOP

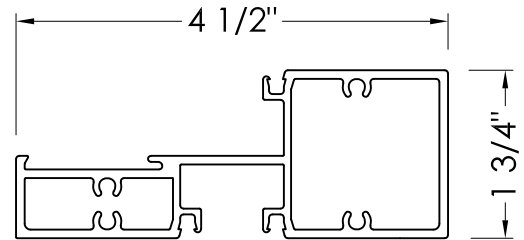

SF173
HORIZONTAL / SILL

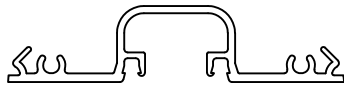

SF171
MULLION FILLER

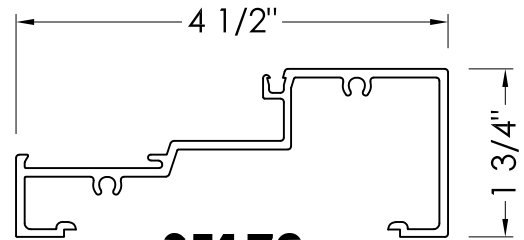

SF172
HORIZONTAL / SILL

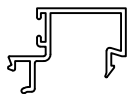

SF175
DOOR STOP

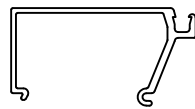

SF174
GLAZING STOP



SF178
POCKET FILLER

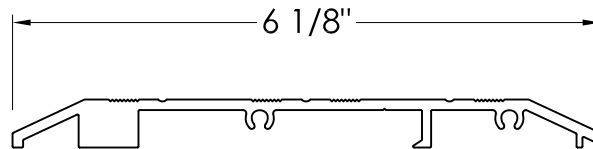

T-HOLD 1
DOOR THRESHOLD

SF175 SERIES STOREFRONT

TYPICAL DETAILS

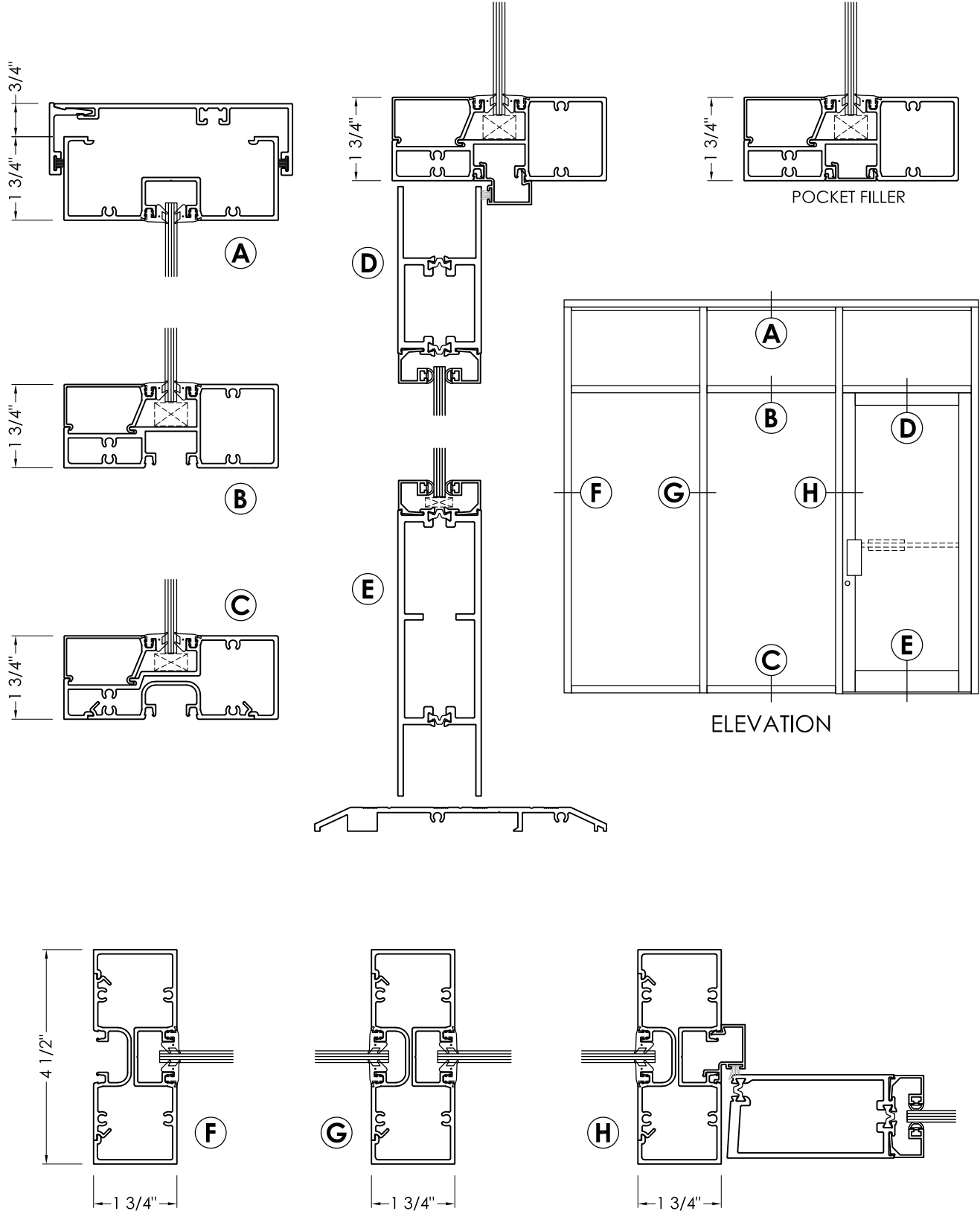

SF200 SERIES STOREFRONT

SYSTEM PARTS

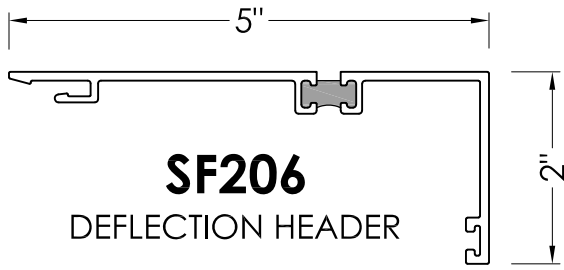

SF206
DEFLECTION HEADER

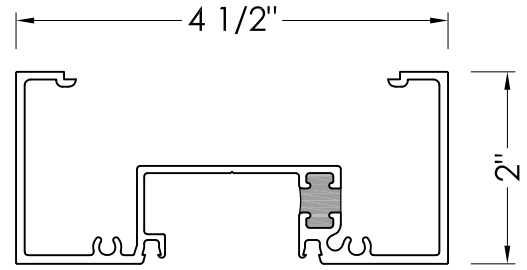

SF200
HEAD / JAMB / VERTICAL

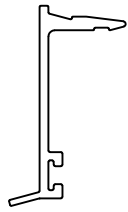

SF207
DEFL. HEADER STOP

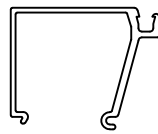

SF204
GLAZING STOP

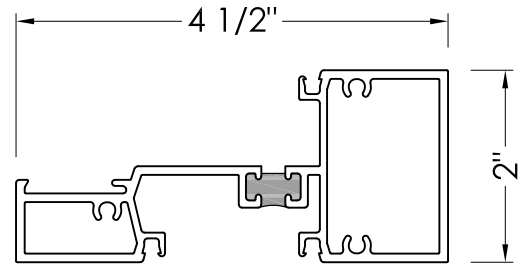

SF203
HORIZONTAL / SILL

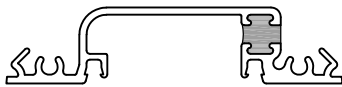

SF201
MULLION FILLER

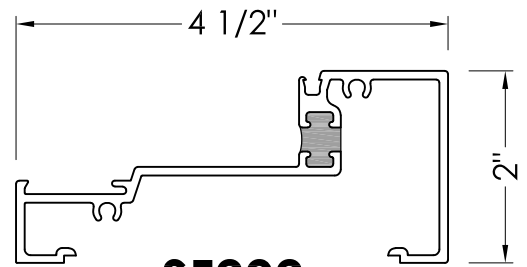

SF202
HORIZONTAL / SILL

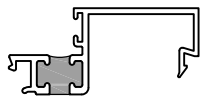

SF205
DOOR STOP



SF208
POCKET FILLER

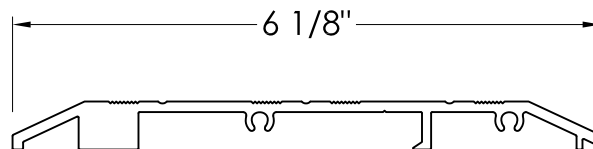

T-HOLD 1
DOOR THRESHOLD

SF200 SERIES STOREFRONT

TYPICAL DETAILS

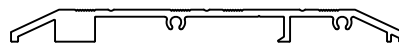
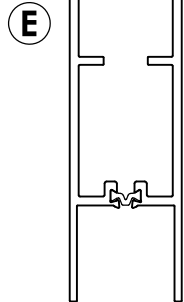
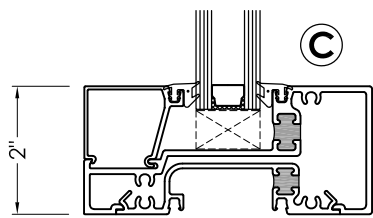
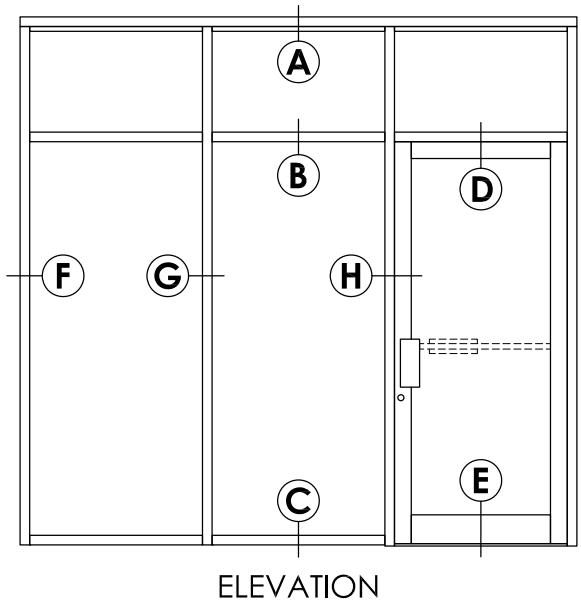
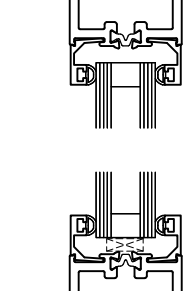
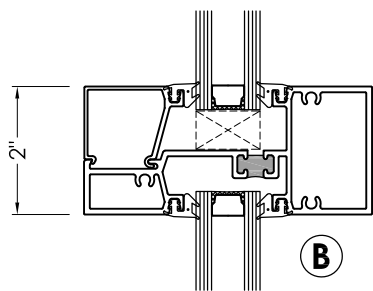
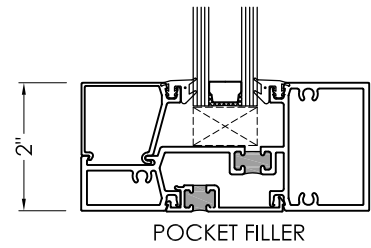
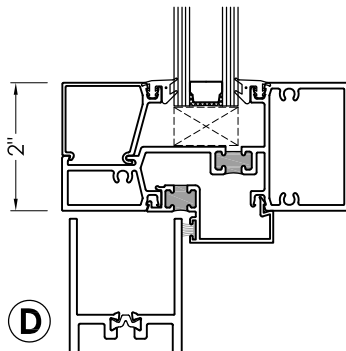
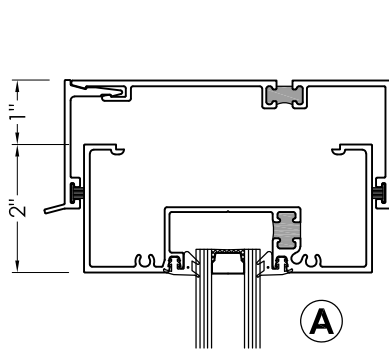

OPTIONAL STEEL

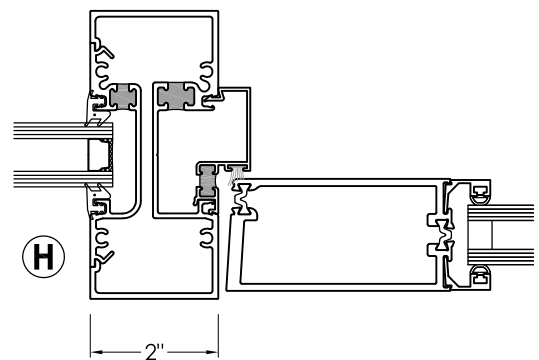
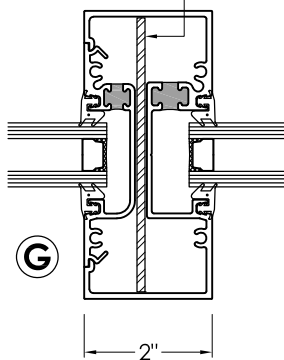
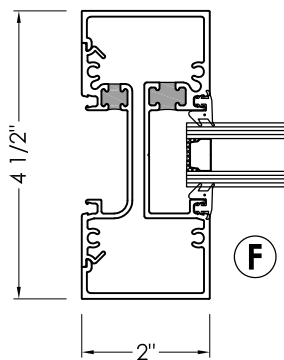

CW200 SERIES CURTAIN WALL

SYSTEM PARTS

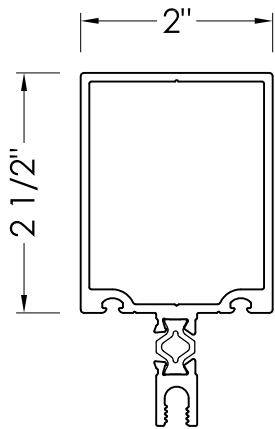

CW202
D/G MULLION

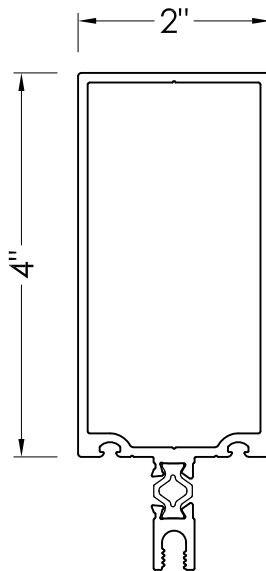

CW204
D/G MULLION

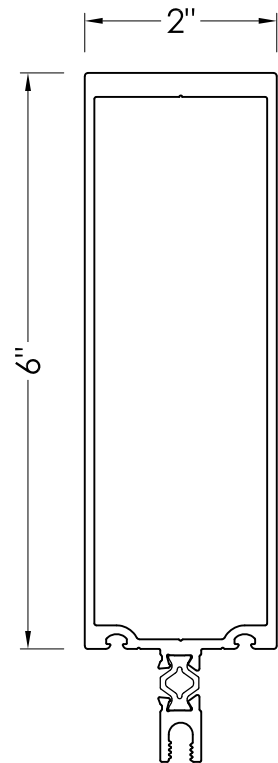

CW206
D/G MULLION

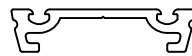

CW203
PRESSURE PLATE

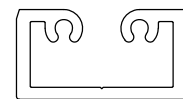

CW205
SHEAR BLOCK

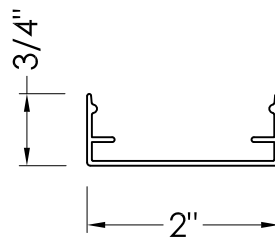

CW201
BEAUTY CAP

CW200 SERIES CURTAIN WALL

SYSTEM PARTS



CWSG
S/G ADAPTER

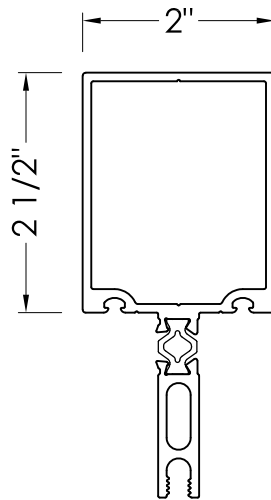

CW302
T/G MULLION

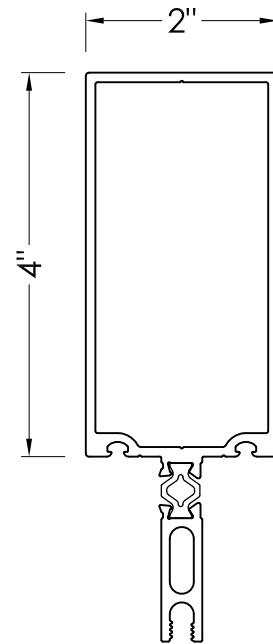

CW304
T/G MULLION

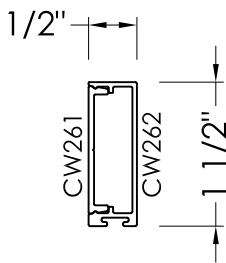

CW261
CW262
DOOR STOP

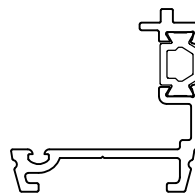

CW253
DOOR ADAPTER
PRESSURE PLATE

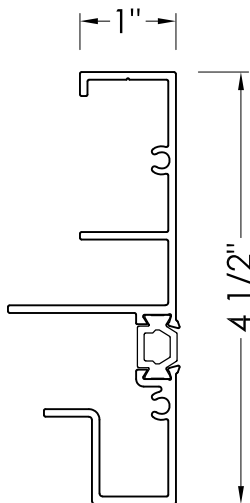

CW209
DOOR ADAPTER

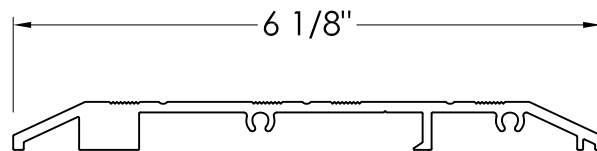

T-HOLD 1
DOOR THRESHOLD

CW200 SERIES CURTAIN WALL

TYPICAL DETAILS

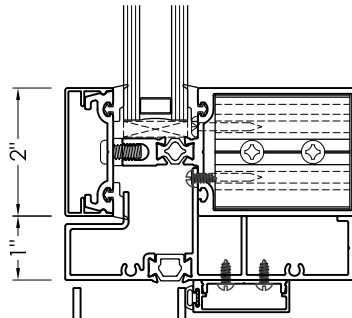
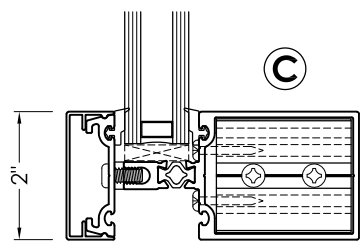
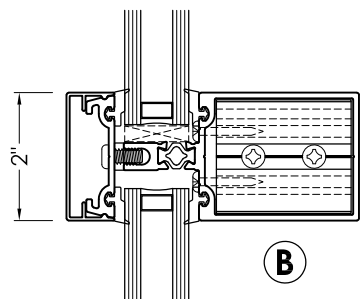
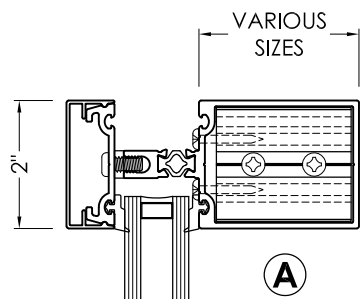

D

E

E

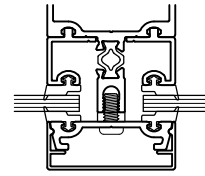
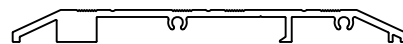

S/G
ADAPTER

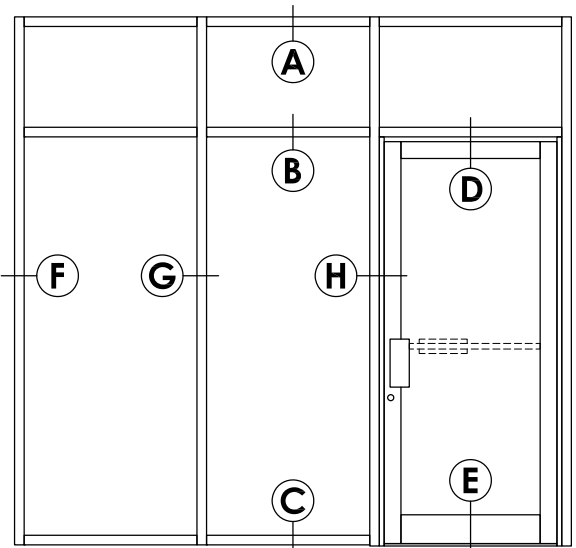

ELEVATION

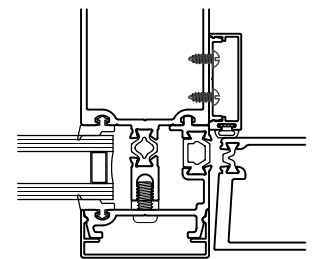

FLUSH
DOOR ADAPTER

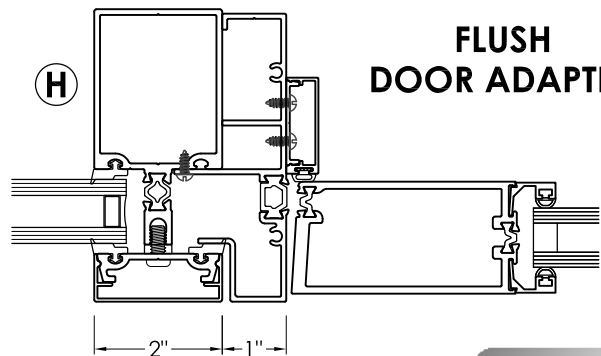
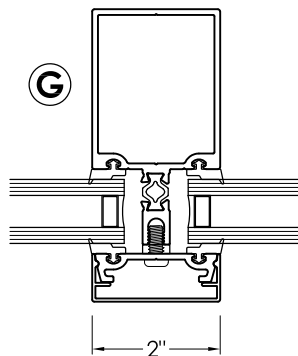
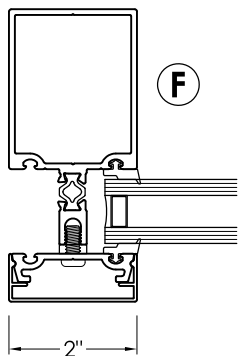

CW250 SERIES CURTAIN WALL

SYSTEM PARTS

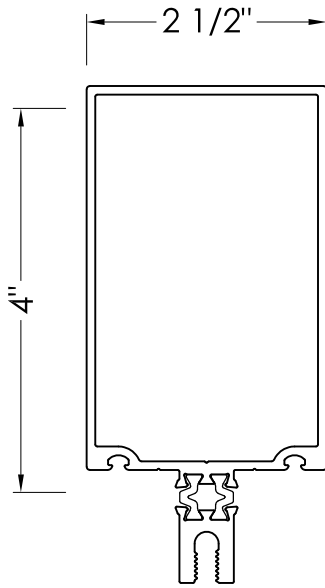

CW254
D/G MULLION

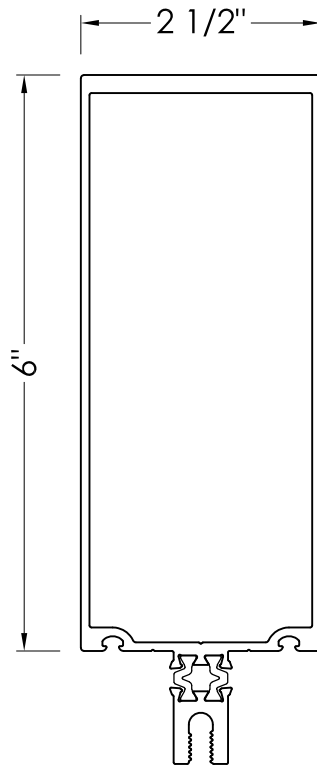

CW256
D/G MULLION

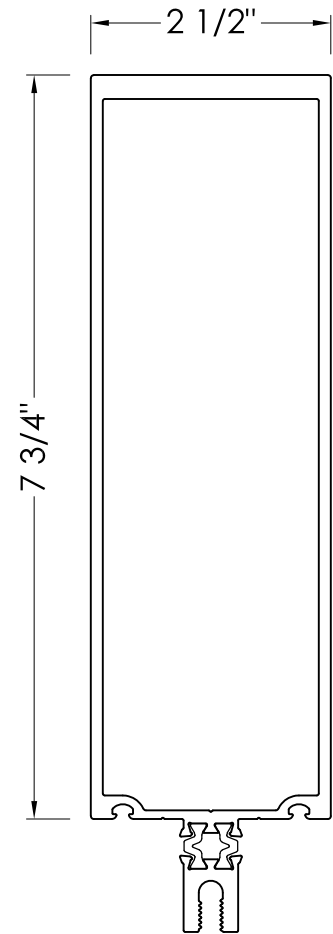

CW258
D/G MULLION

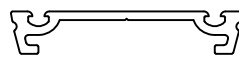

CW251
PRESSURE PLATE

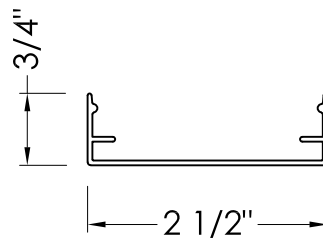

CW252
BEAUTY CAP

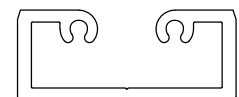

CW253
SHEAR BLOCK

CW250 SERIES CURTAIN WALL

SYSTEM PARTS

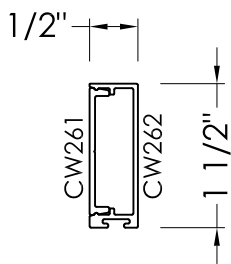

CW261
CW262
DOOR STOP

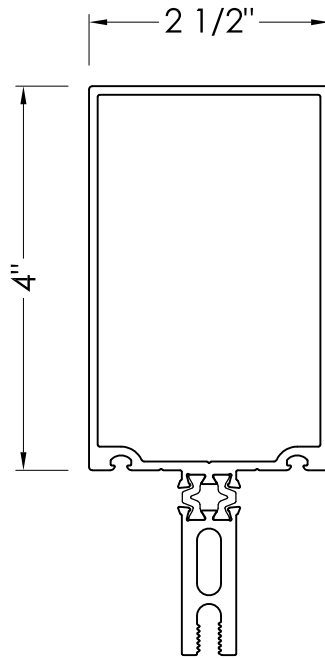

CW354
T/G MULLION

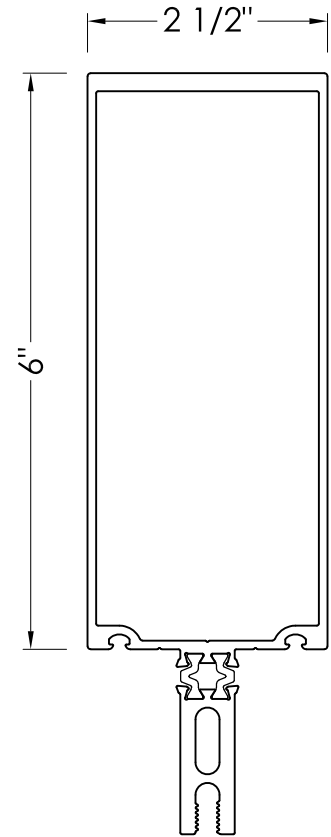

CW356
T/G MULLION

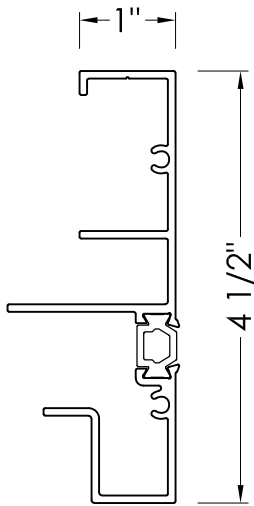

CW209
DOOR ADAPTER

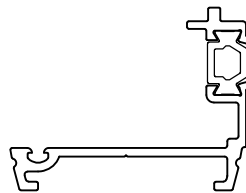

CW253
DOOR ADAPTER
PRESSURE PLATE

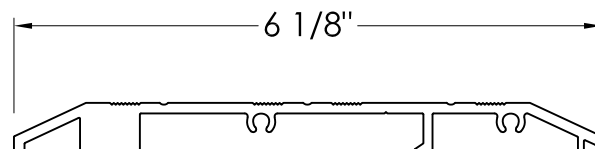

T-HOLD 1
DOOR THRESHOLD

CW250 SERIES CURTAIN WALL

TYPICAL DETAILS

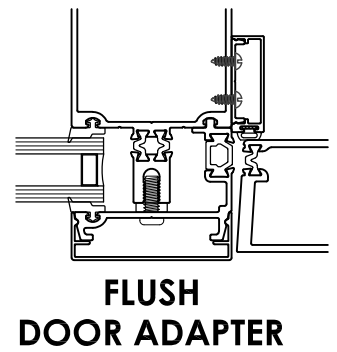
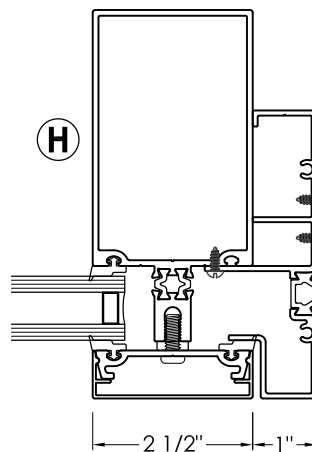
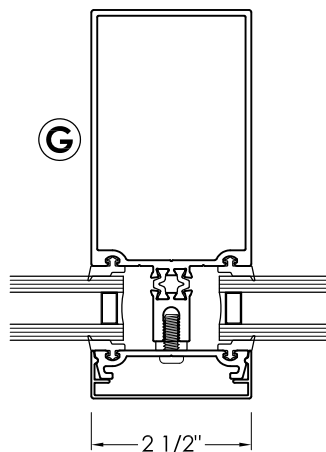
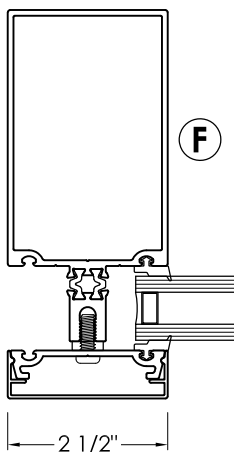
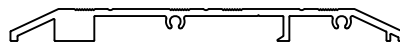
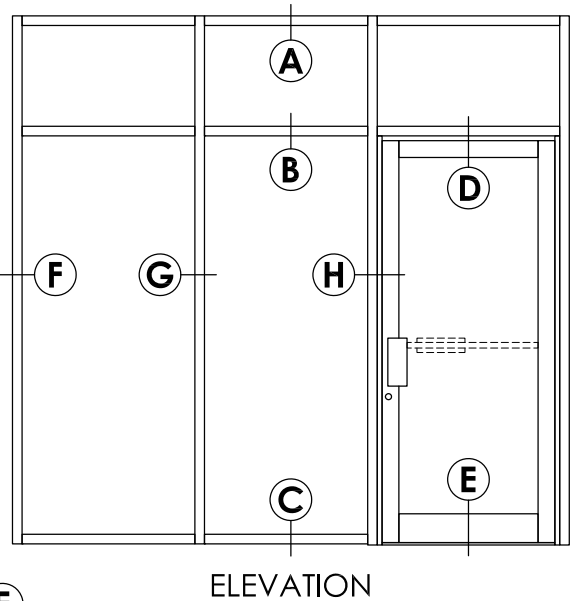
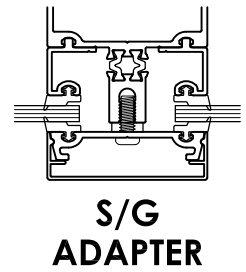
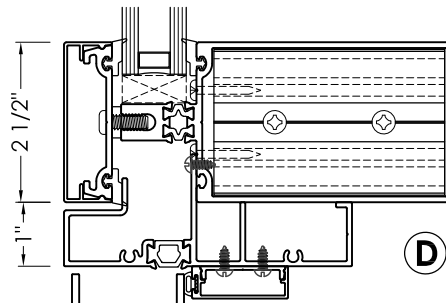
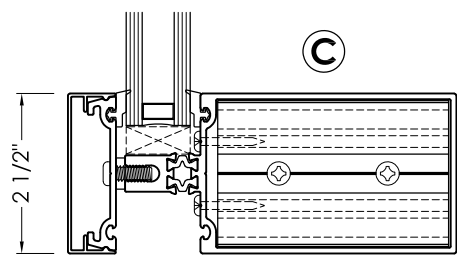
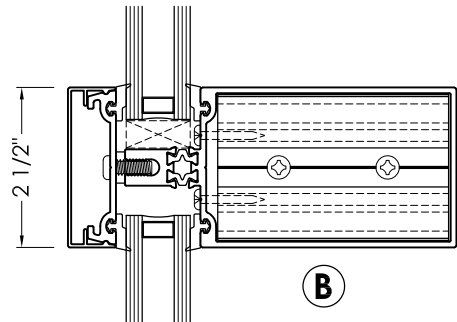
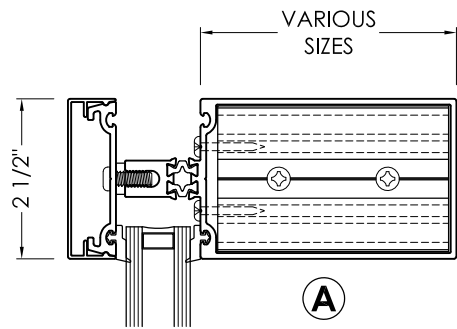

MISCELLANEOUS

SYSTEM PARTS

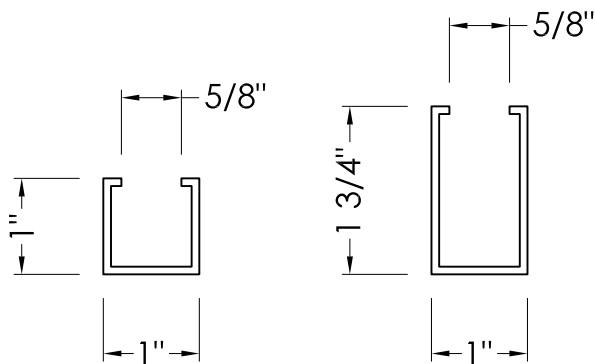

U100

U CHANNEL

U175

U CHANNEL

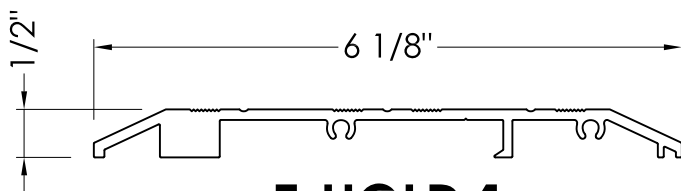

T-HOLD 1

DOOR THRESHOLD

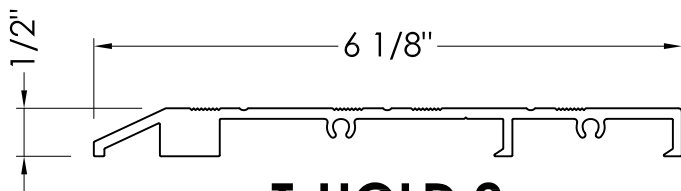

T-HOLD 2

DOOR THRESHOLD

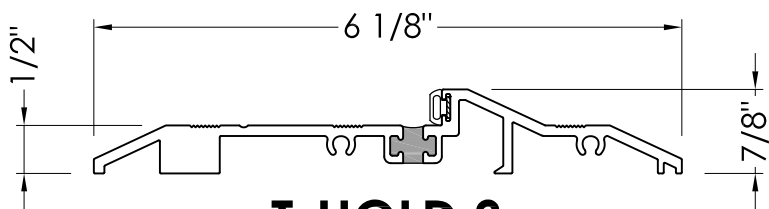

T-HOLD 3

DOOR THRESHOLD

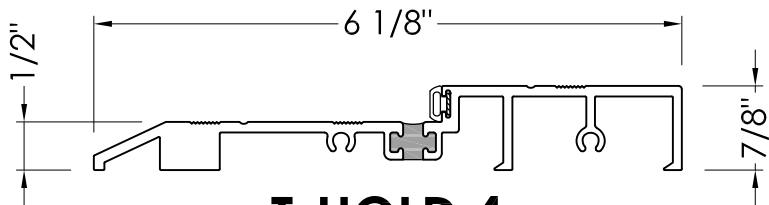

T-HOLD 4

DOOR THRESHOLD

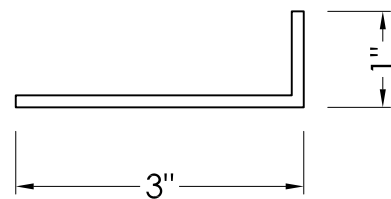

L300

ALUM ANGLE

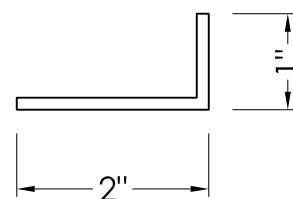

L200

ALUM ANGLE

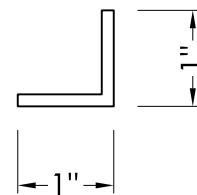

L100

ALUM ANGLE

MISCELLANEOUS

SYSTEM PARTS

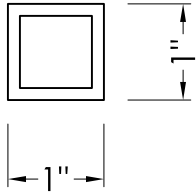

T100
ALUM TUBE

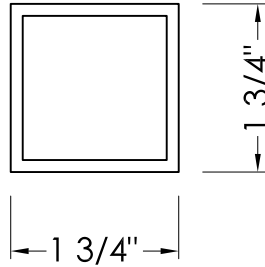

T175
ALUM TUBE

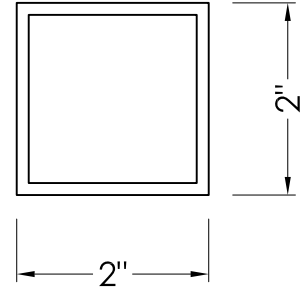

T200
ALUM TUBE

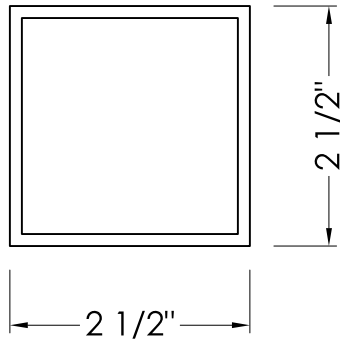

T200
ALUM TUBE

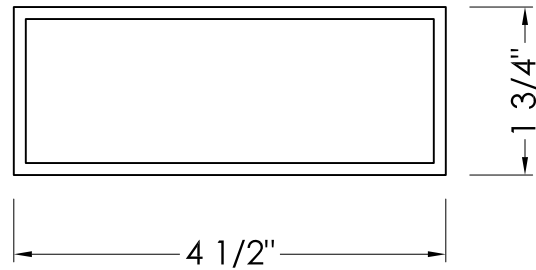

T450
ALUM TUBE